

TEST REPORT

Product Name : DataHub
Model Number : DataHub1000

Prepared for : SOLAX POWER NETWORK TECHNOLOGY (ZHEJIANG)
CO., LTD.
Address : No.288, Shizhu Road, Tonglu Economic Development Zone,
Tonglu City, Zhejiang Province 310000, P. R. China

Prepared by : EMTEK (NINGBO) CO., LTD.
Address : 1F Building 4, 1177#, Lingyun Road, Ningbo National Hi-Tech
Zone, Ningbo, Zhejiang, China.

Tel: +86-574-27907998
Fax: +86-574-27721538

Report Number : ENB2111250113E01001R
Date(s) of Tests : November 25, 2021 to December 03, 2021
Date of issue : December 03, 2021



TABLE OF CONTENT

Test Report Description	Page
1. SUMMARY OF TEST RESULTS	5
2. GENERAL INFORMATION	6
2.1. Description of Device (EUT)	6
2.2. Input / Output Ports	6
2.3. Independent Operation Modes	7
2.4. Test Manner	7
2.5. Description of Test Facility	7
2.6. Test Software	7
2.7. Description of Support Device	8
2.8. Measurement Uncertainty	8
3. MEASURING DEVICE AND TEST EQUIPMENT	9
3.1. For Power Line Conducted Emission Measurement	9
3.2. For Radiated Emission Measurement	9
4. POWER LINE CONDUCTED EMISSION MEASUREMENT	10
4.1. Block Diagram of Test Setup	10
4.2. Conducted Limit	10
4.3. Test Procedure	10
4.4. Measuring Results	11
4.5. Block Diagram of Test Setup	14
4.6. Radiated Limit	14
4.7. Test Procedure	14
4.8. Measuring Results	15
4.9. Block Diagram of Test Setup	18
4.10. Radiated Limit	18
4.11. Test Procedure	18
4.12. Measuring Results	19
5. PHOTOGRAPHS	19
5.1. Photo of Conducted Emission Measurement	21
5.2. Photo of Radiation Emission Measurement (Up to 1GHz)	22
APPENDIX A: Warning Labels (1 Page)	
APPENDIX B: Warning Statement (1 Page)	
APPENDIX C: Photos of EUT (7 Pages)	

TEST REPORT DESCRIPTION

Applicant : SOLAX POWER NETWORK TECHNOLOGY (ZHEJIANG) CO., LTD.
Manufacturer : SOLAX POWER NETWORK TECHNOLOGY (ZHEJIANG) CO., LTD.
Trade Mark : SolaX Power
EUT : DataHub
Model No. : DataHub1000
Power Supply : AC 100-240V, 50/60Hz, 24W

Measurement Procedure Used:

FCC CFR Title 47, Part 15, Subpart B
ANSI C63.4-2014

The device described above is tested by EMTEK (NINGBO) CO., LTD. to determine the maximum emission levels emanating from the device and the severe levels of the device can endure and its performance criterion. The measurement results are contained in this test report and EMTEK (NINGBO) CO., LTD. is assumed full of responsibility for the accuracy and completeness of these measurements. Also, this report shows that the EUT (Equipment Under Test) is technically compliant with the FCC requirements.

This report applies to above tested sample only and shall not be reproduced in part without written approval of EMTEK (NINGBO) CO., LTD.

Date of Test : November 25, 2021 to December 03, 2021

Prepared by : 
June Gao/Engineer

Reviewer : 
Ade Wang/Supervisor

Approved & Authorized Signer : 
Tony Wei/Manager



Modified Information

Version	Report No.	Revision date	Summary
	ENB2111250113E01001R	/	Original Report



1. SUMMARY OF TEST RESULTS

EMISSION		
Description of Test Item	Standard & Limits	Results
Conducted Emission at Mains Terminals	FCC CFR Title 47, Part 15, Subpart B, Class B ANSI C63.4-2014	Pass
Radiated Emission	FCC CFR Title 47, Part 15, Subpart B, Class B ANSI C63.4-2014	Pass
Note: N/A is an abbreviation for Not Applicable.		



2. GENERAL INFORMATION

2.1. Description of Device (EUT)

EUT : DataHub

Model Number : DataHub1000

Test Voltage : AC 120V/60Hz

AC Adapter : M/N: ABT020120A
 Input: AC 100-240V, 50/60Hz, 1.5A
 Output: DC 12V, 2A, 24W

Highest Frequency : 2480 MHz

Sample Number : 1#

Applicant : SOLAX POWER NETWORK TECHNOLOGY (ZHEJIANG) CO., LTD.

Address : No.288, Shizhu Road, Tonglu Economic Development Zone, Tonglu City, Zhejiang Province 310000, P. R. China

Manufacturer : SOLAX POWER NETWORK TECHNOLOGY (ZHEJIANG) CO., LTD.

Address : No.288, Shizhu Road, Tonglu Economic Development Zone, Tonglu City, Zhejiang Province 310000, P. R. China

Date of Received : November 25, 2021

Date of Test : November 25, 2021 to December 03, 2021

2.2. Input / Output Ports

Port #	Name	Type*	Cable Max. >3m	Cable Shielded	Comments
1	Enclosure	N/E	--	--	None
2	RS485	A/D	--	--	None
3	Net Port	A/D	--	--	None

* Note: Use abbreviations:

AC= AC Power Port

DC= DC Power Port

N/E= Non-Electrical

I/O= Signal Input or Output Port (Not Involved in Process Control)

TP= Telecommunication Ports

2.3. Independent Operation Modes

A. ON

2.4. Test Manner

Test Items	Test Voltage	Operation Modes	Worst case
Conducted Emission at Mains Terminals	AC 120V/60Hz	Mode A	Mode A
Radiated Emission up to 1 GHz	AC 120V/60Hz	Mode A	Mode A
Radiated Emission above 1 GHz	AC 120V/60Hz	Mode A	Mode A

2.5. Description of Test Facility

Site Description

EMC Lab.

: **Accredited by CNAS**

The Certificate Registration Number is L6666.

The Laboratory has been assessed and proved to be in compliance with CNAS-CL01:2018 (identical to ISO/IEC 17025:2017)

Accredited by FCC

Designation Number: CN1302

Test Firm Registration Number: 436491

Accredited by A2LA

The certificate is valid until May 31, 2023

Accredited by Industry Canada

The Conformity Assessment Body Identifier is CN0114

Name of Firm : EMTEK (NINGBO) CO., LTD.

Site Location : 1F Building 4, 1177#, Lingyun Road, Ningbo National Hi-Tech Zone, Ningbo, Zhejiang, China.

2.6. Test Software

Item : Software
Conducted Emission : EZ-EMC (Ver. CON-03A1)

Radiated Emission : EZ-EMC (Ver. EMEC-3A1)

2.7. Description of Support Device

Notebook	:	Manufacturer: LENOVO M/N: T430s S/N: R9RK4YK
Notebook	:	Manufacturer: ASUS M/N: FX80G S/N: J7NRCX03D694281
Wireless router	:	Manufacturer: TP-LINK M/N: TL-WR886N S/N: 1156004013356

2.8. Measurement Uncertainty

Test Item	Uncertainty
Conducted Emission Uncertainty	: 2.08dB (9 k-150 kHz)
	2.40dB (150 k-30 MHz)
Radiated Emission Uncertainty (3m Chamber)	: 4.06 dB (Polarize: H) (30MHz-1000MHz)
	4.04 dB (Polarize: V) (30MHz-1000MHz)
	4.82 dB (Polarize: H) (1~18GHz)
	4.80 dB (Polarize: V) (1~18GHz)

3. MEASURING DEVICE AND TEST EQUIPMENT

3.1. For Power Line Conducted Emission Measurement

Item	Equipment	Manufacturer	Model No.	Serial No.	Last Cal.	Cal. Interval
<input checked="" type="checkbox"/>	Test Receiver	Rohde & Schwarz	ESCI	101108	July 08, 2021	1 Year
<input checked="" type="checkbox"/>	L.I.S.N	Rohde & Schwarz	ENV216	101193	July 08, 2021	1 Year
<input checked="" type="checkbox"/>	L.I.S.N	Schwarzbeck	NSLK 8126	8126-462	July 08, 2021	1 Year
<input checked="" type="checkbox"/>	Pulse Limiter	MTS-systemtechnik	IMP-136	2611115-001-0033	July 08, 2021	1 Year
<input checked="" type="checkbox"/>	RF Switching unit	Compliance Direction Systems Inc.	RSU-M2	38400	July 08, 2021	1 Year

3.2. For Radiated Emission Measurement

Item	Equipment	Manufacturer	Model No.	Serial No.	Last Cal.	Cal. Interval
<input checked="" type="checkbox"/>	Spectrum Analyzer	Rohde & Schwarz	ESCI	101107	July 08, 2021	1 Year
<input checked="" type="checkbox"/>	EMI Test Receiver	Rohde & Schwarz	ESCI	101107	July 08, 2021	1 Year
<input checked="" type="checkbox"/>	Pre-Amplifier	CD	PAP-0203	22015	July 08, 2021	1 Year
<input checked="" type="checkbox"/>	Bilog Antenna	Schwarzbeck	VULB9163	9163-467	July 12, 2020	2 Year
<input checked="" type="checkbox"/>	Cable	HUBER + SUHNER	CBL3-NN-0.5M	101216-2140500-2	July 08, 2021	1 Year
<input checked="" type="checkbox"/>	Cable	HUBER + SUHNER	CBL3-NN-3.0M	101216-2143000-2	July 08, 2021	1 Year
<input checked="" type="checkbox"/>	Cable	HUBER + SUHNER	CBL3-NN-9.0M	101216-2149000	July 08, 2021	1 Year
<input checked="" type="checkbox"/>	Spectrum Analyzer	Agilent	E4407B	MY45107013	April 08, 2021	1 Year
<input checked="" type="checkbox"/>	Pre-Amplifier	Connphy Microwave Inc.	GLN-1G40G-4165-K	0319104	Nov 22, 2021	1 Year
<input checked="" type="checkbox"/>	Horn Antenna	Schwarzbeck	BBHA 9120	9120D-707	April 13, 2021	2 Year
<input checked="" type="checkbox"/>	Cable	SMAMSMAM	A50-0.5M	N/A	July 08, 2021	1 Year
<input checked="" type="checkbox"/>	Cable	SMAMSMAM	A50-3M	N/A	July 08, 2021	1 Year
<input checked="" type="checkbox"/>	Cable	SMAMSMAM	A50-6M	N/A	July 08, 2021	1 Year
<input checked="" type="checkbox"/>	Band Reject Filter	O.M.Jones, Inc. dba	BRM50702-0	G049	July 08, 2021	1 Year
<input type="checkbox"/>	Band Reject Filter	COM-MW Technology co.,Ltd	ZBSF3-C431.4-436.4-751	07204734	July 08, 2021	1 Year

4. POWER LINE CONDUCTED EMISSION MEASUREMENT

4.1. Block Diagram of Test Setup

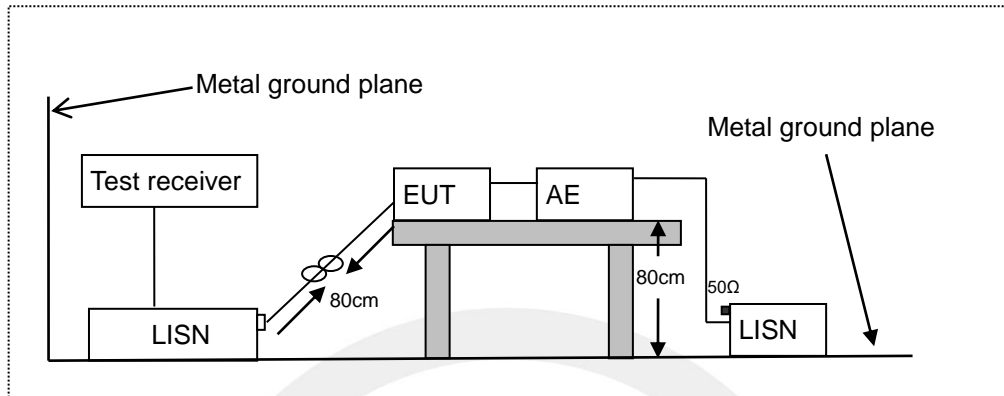

LISN: Line Impedance Stabilization Network
 AE: Associated equipment
 EUT: Equipment under test

4.2. Conducted Limit

FCC CFR Title 47, Part 15, Subpart B, Class B

Frequency (MHz)	Limit (dB μ V)	
	Quasi-peak Level	Average Level
0.15 ~ 0.50	66.0 ~ 56.0 *	56.0 ~ 46.0 *
0.50 ~ 5.00	56.0	46.0
5.00 ~ 30.00	60.0	50.0

NOTE1-The lower limit shall apply at the transition frequencies.
 NOTE2-The limit decreases linearly with the logarithm of the frequency in the range 0.15MHz to 0.50MHz.

4.3. Test Procedure

The EUT was placed on a desk 0.8 m height from the metal ground plane and 0.4 m from the conducting wall of the shielding room and it was kept at least 0.8 m from any other grounded conducting surface. The size of the table will nominally be 1.5 m x1.0 m.

The rear of the arrangement shall be flush with the back of the supporting tabletop unless that would not be possible or typical of normal use.

All units of equipment forming the system under test (includes the EUT as well as connected peripherals and associated equipment or devices) shall be arranged such that a nominal 0.1 m separation is achieved between the neighboring units.

Connect EUT to the power mains through a line impedance stabilization network (LISN). Where the mains cable supplied by the manufacturer is longer than 1 m, the excess should be folded at the centre into a bundle no longer than 0.4 m, so that its length is shortened to 1 m.

All the support units are connecting to the other LISN.

The LISN provides 50 ohm coupling impedance for the measuring instrument.

Both sides of AC line were checked for maximum conducted interference.

The frequency range from 150 kHz to 30 MHz was sweep.

Set the test-receiver system to quasi peak detect function and average detect function, and to measure the conducted emissions values.

Test results were obtained from the following equation:
Measurement (dB μ V) = Correct Factor (dB) + Reading (dB μ V)
Over (dB) = Measurement (dB μ V) - Limit (dB μ V)

4.4. Measuring Results

Pass.

Please refer to following pages.



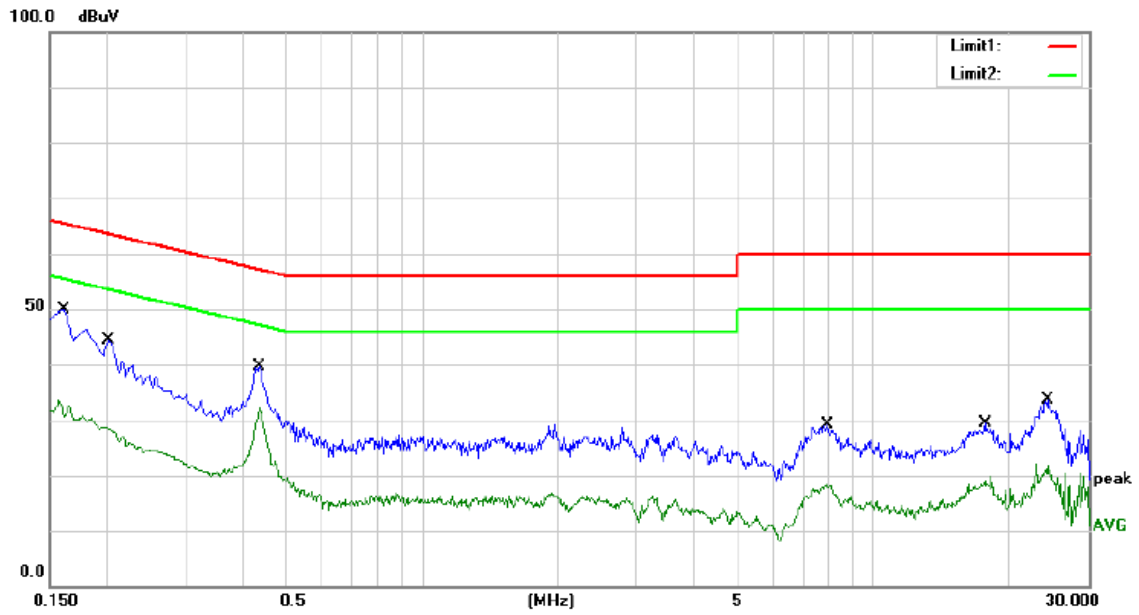

Site site #1 Phase: **L1** Temperature: 24
 Limit: (CE)FCC PART 15 class B_QP Power: AC 120V/60Hz Humidity: 50 %
 Mode: ON
 Note:

No.	Mk.	Freq. MHz	Reading Level dBuV	Correct Factor dB	Measure- ment dBuV	Limit dBuV	Over dB	Detector	Comment
1		0.1620	39.80	10.10	49.90	65.36	-15.46	QP	
2		0.1620	20.50	10.10	30.60	55.36	-24.76	AVG	
3		0.2020	34.20	10.09	44.29	63.53	-19.24	QP	
4		0.2020	18.30	10.09	28.39	53.53	-25.14	AVG	
5		0.4380	29.60	10.07	39.67	57.10	-17.43	QP	
6	*	0.4380	22.00	10.07	32.07	47.10	-15.03	AVG	
7		7.9580	18.60	10.43	29.03	60.00	-30.97	QP	
8		7.9580	7.30	10.43	17.73	50.00	-32.27	AVG	
9		17.6940	18.60	10.58	29.18	60.00	-30.82	QP	
10		17.6940	7.40	10.58	17.98	50.00	-32.02	AVG	
11		24.3500	22.90	10.70	33.60	60.00	-26.40	QP	
12		24.3500	10.40	10.70	21.10	50.00	-28.90	AVG	

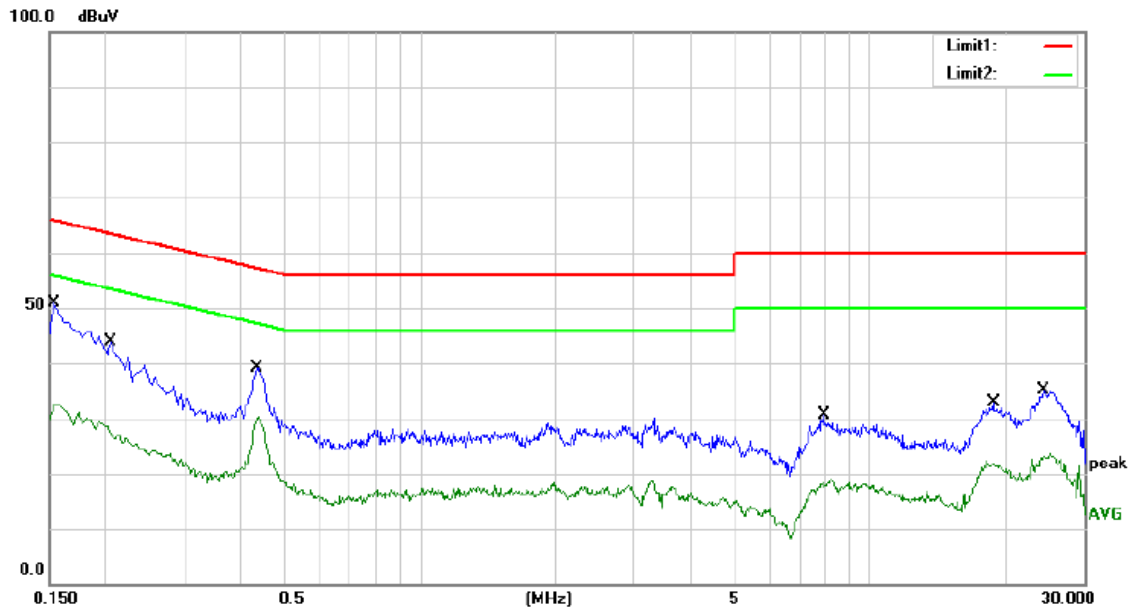

Site site #1 Phase: **N** Temperature: 24
 Limit: (CE)FCC PART 15 class B_QP Power: AC 120V/60Hz Humidity: 50 %
 Mode: ON
 Note:

No.	Mk.	Freq. MHz	Reading Level dBuV	Correct Factor dB	Measure- ment dBuV	Limit dBuV	Over dB	Detector	Comment
1	*	0.1540	40.80	10.08	50.88	65.78	-14.90	QP	
2		0.1540	22.40	10.08	32.48	55.78	-23.30	AVG	
3		0.2060	33.70	10.08	43.78	63.37	-19.59	QP	
4		0.2060	17.00	10.08	27.08	53.37	-26.29	AVG	
5		0.4340	29.10	10.10	39.20	57.18	-17.98	QP	
6		0.4340	19.90	10.10	30.00	47.18	-17.18	AVG	
7		7.9220	20.10	10.45	30.55	60.00	-29.45	QP	
8		7.9220	7.20	10.45	17.65	50.00	-32.35	AVG	
9		18.9140	22.10	10.65	32.75	60.00	-27.25	QP	
10		18.9140	10.80	10.65	21.45	50.00	-28.55	AVG	
11		24.2900	24.40	10.54	34.94	60.00	-25.06	QP	
12		24.2900	12.70	10.54	23.24	50.00	-26.76	AVG	

5. RADIATED EMISSION MEASUREMENT(UP TO 1GHz)

5.1. Block Diagram of Test Setup

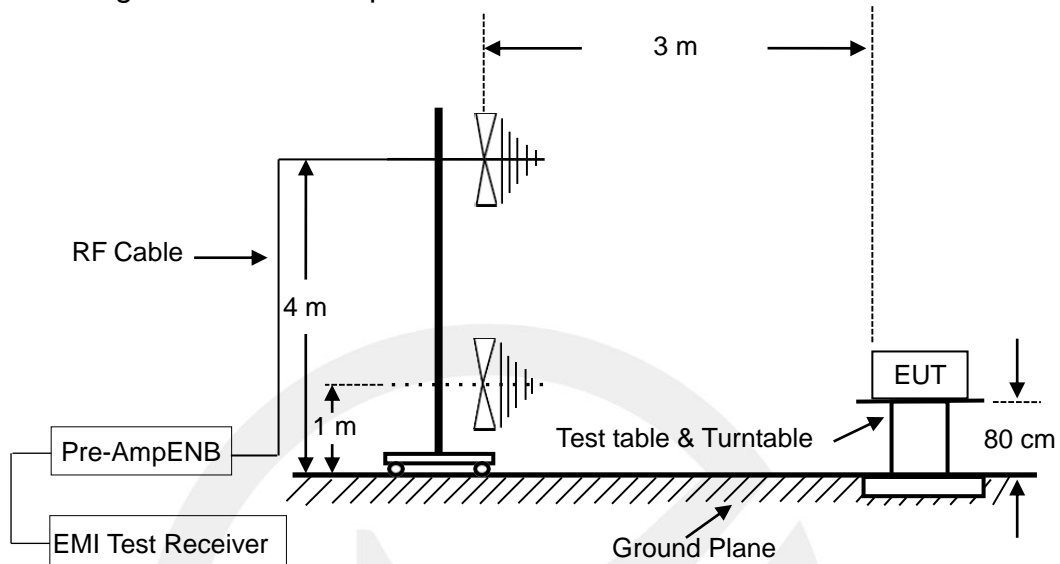

5.2. Radiated Limit

FCC CFR Title 47, Part 15, Subpart B, Class B

Frequency MHz	Distance Meters	Field Strengths Limit	
		$\mu\text{V}/\text{m}$	$\text{dB}(\mu\text{V})/\text{m}$
30 ~ 88	3	100	40.0
88 ~ 216	3	150	43.5
216 ~ 960	3	200	46.0
960 ~ 1000	3	500	54.0

5.3. Test Procedure

The EUT was placed on a non-conductive table whose total height equaled 80cm. All units of equipment forming the system under test (includes the EUT as well as connected peripherals and associated equipment or devices) shall be arranged such that a nominal 0.1 m separation is achieved between the neighboring units. Where the mains cable supplied by the manufacturer is longer than 1 m, the excess should be folded at the centre into a bundle no longer than 0.4 m, so that its length is shortened to 1 m.

The EUT was set 3 meters away from the receiving antenna that was mounted on a non-conductive mast. The antenna can move up and down between 1 to 4 meters to find out the maximum emission level.

The turntable can rotate 360 degree to determine the position of the maximum emission level.

The initial testing identified the frequency that has the highest disturbance relative to the limit while operating the EUT in typical modes of operation and cable positions in a test setup representative of typical system configuration.

The identification of the frequency of highest emission with respect to the limit was found by investigating emissions at a number of significant frequencies. The probable frequency of maximum emission had been found and that the associated cable and EUT configuration and mode of operation had been identified.

The bandwidth of the Receiver is set at 120 kHz.

Test results were obtained from the following equation:

Measurement (dB μ V) = Correct Factor (dB) + Reading (dB μ V)

Over (dB) = Measurement (dB μ V) - Limit (dB μ V)

5.4. Measuring Results

Pass.

Please refer to following pages.



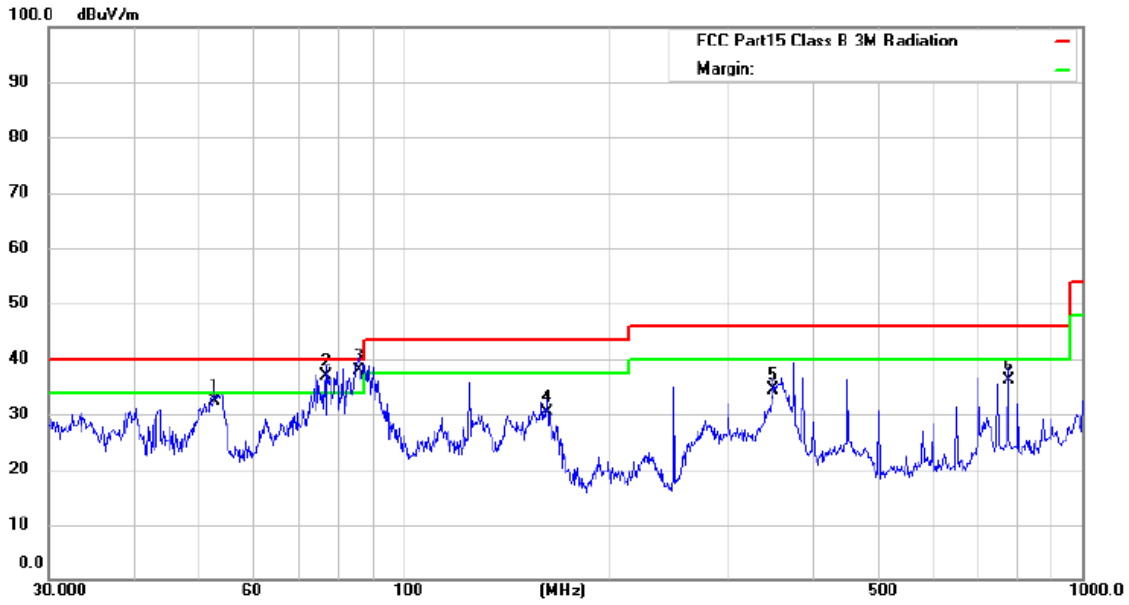

Site Radiated Emission 3m #1

Polarization: *Vertical*

Temperature: 24

Limit: FCC Part15 Class B 3M Radiation

Power: AC 120V/60Hz

Humidity: 55 %

Mode: ON

Note:

No.	Mk.	Freq.	Reading Level	Correct Factor	Measurement	Limit	Over	Antenna Height	Table Degree	
		MHz	dBuV	dB	dBuV/m	dBuV/m	dB	cm	degree	Comment
1		52.5752	53.52	-21.02	32.50	40.00	-7.50	QP		
2	!	77.0503	64.20	-27.40	36.80	40.00	-3.20	QP		
3	*	85.8984	64.37	-26.47	37.90	40.00	-2.10	QP		
4		162.6105	57.28	-26.98	30.30	43.50	-13.20	QP		
5		350.4766	54.07	-19.57	34.50	46.00	-11.50	QP		
6		776.8777	45.86	-9.66	36.20	46.00	-9.80	QP		

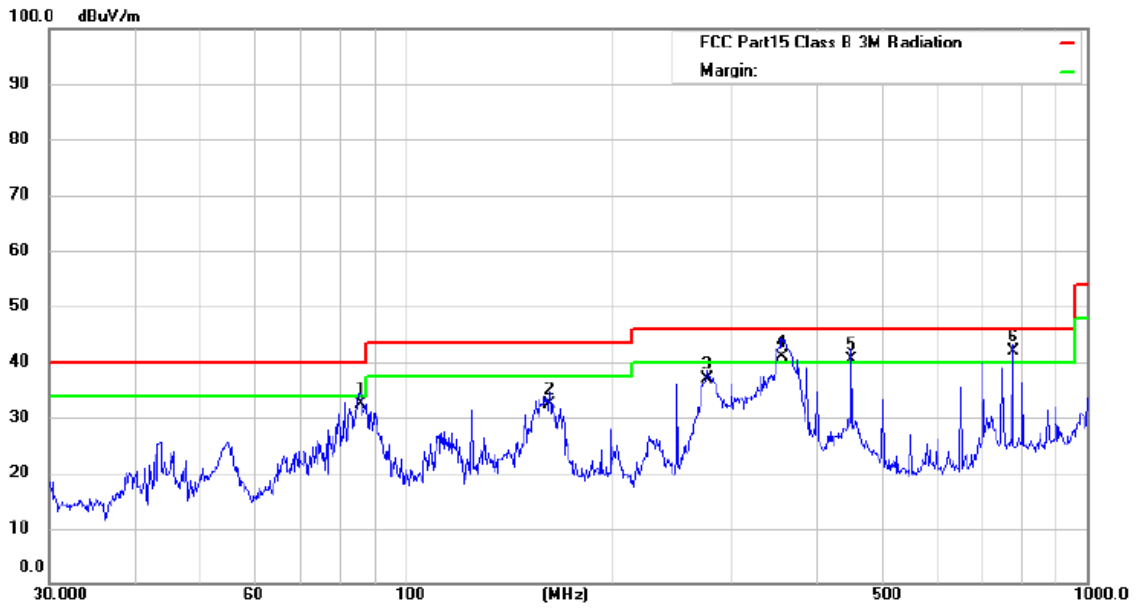

Site Radiated Emission 3m #1

Polarization: **Horizontal**

Temperature: 24

Limit: FCC Part15 Class B 3M Radiation

Power: AC 120V/60Hz

Humidity: 55 %

Mode: ON

Note:

No.	Mk.	Freq. MHz	Reading Level dBuV	Correct Factor dB	Measure- ment dBuV/m	Limit dBuV/m	Over dB	Detector	Antenna Height cm	Table Degree degree	Comment
1		85.8983	58.97	-26.47	32.50	40.00	-7.50	QP			
2		162.6105	59.38	-26.98	32.40	43.50	-11.10	QP			
3		277.0935	57.43	-20.63	36.80	46.00	-9.20	QP			
4	!	355.4273	60.50	-19.50	41.00	46.00	-5.00	QP			
5	!	451.1349	58.63	-18.33	40.30	46.00	-5.70	QP			
6	*	776.8778	51.56	-9.66	41.90	46.00	-4.10	QP			

6. RADIATED EMISSION MEASUREMENT (ABOVE 1GHz)

6.1. Block Diagram of Test Setup

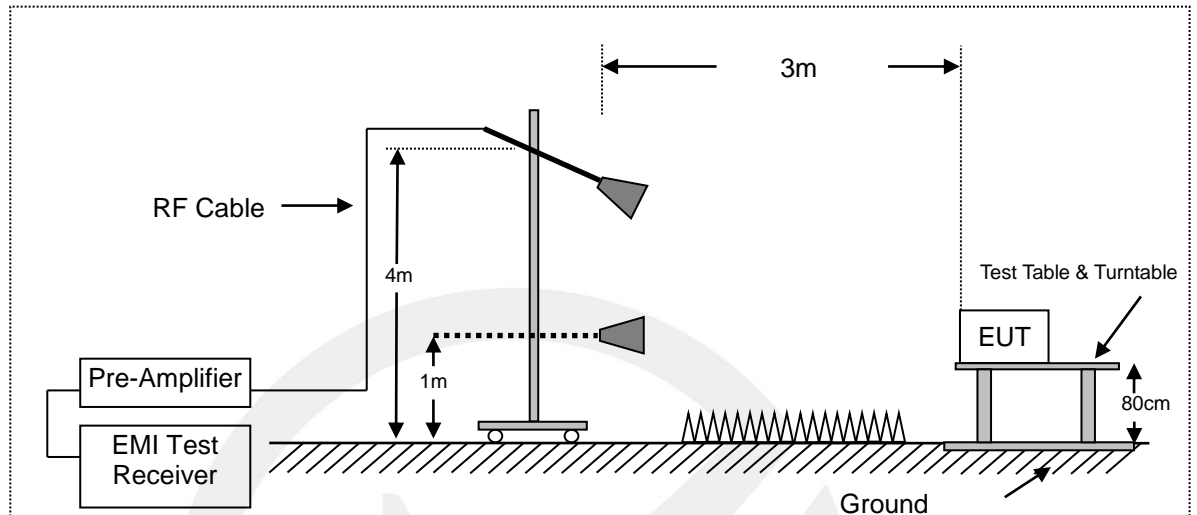

6.2. Radiated Limit

FCC CFR Title 47, Part 15, Subpart B, Class B

Frequency range GHz	Average limit dB(μ V/m)	Peak limit dB(μ V/m)
Above 1000	54	74

Note: The highest internal source of an EUT is defined as the highest frequency generated or used in the device or on which the EUT operates or tunes. If the highest frequency of the internal sources of the EUT is less than 1.705 MHz, the measurement shall only be made up to 30 MHz. If the highest frequency of the internal sources of the EUT is between 1.705 MHz and 108 MHz, the measurement shall only be made up to 1 GHz. If the highest frequency of the internal sources of the EUT is between 108 MHz and 500 MHz the measurement shall only be made up to 2 GHz. If the highest frequency of the internal sources of the EUT is between 500 MHz and 1 GHz, the measurement shall only be made up to 5 GHz. If the highest frequency of the internal sources of the EUT is above 1 GHz, the measurement shall be made up to 5 times the highest frequency or 40 GHz, whichever is less.

6.3. Test Procedure

The EUT was placed on a non-conductive table whose total height equaled 80cm. All units of equipment forming the system under test (includes the EUT as well as connected peripherals and associated equipment or devices) shall be arranged such that a nominal 0.1 m separation is achieved between the neighboring units. Where the mains cable supplied by the manufacturer is longer than 1 m, the excess should be folded at the centre into a bundle no longer than 0.4 m, so that its length is shortened to 1 m.

The EUT was set 3 meters away from the receiving antenna that was mounted on a non-conductive mast. The antenna can move up and down between 1 to 4 meters to find out the maximum emission level.

The turntable can rotate 360 degree to determine the position of the maximum emission level.

The initial testing identified the frequency that has the highest disturbance relative to the limit while operating the EUT in typical modes of operation and cable positions in a test setup representative of typical system configuration.

The identification of the frequency of highest emission with respect to the limit was found by investigating emissions at a number of significant frequencies. The probable frequency of maximum emission had been found and that the associated cable and EUT configuration and mode of operation had been identified.

The frequency range above 1GHz the measuring instrument use RBW=1 MHz and VBW=3 MHz with peak detector for peak values, and use RBW=1 MHz and VBW=10 Hz with peak detector for Average Values.

Test results were obtained from the following equation:
Measurement (dB μ V) =Correct Factor (dB) + Reading (dB μ V)
Over (dB) = Measurement (dB μ V) - Limit (dB μ V)

6.4. Measuring Results

Pass.

Please refer to following pages.

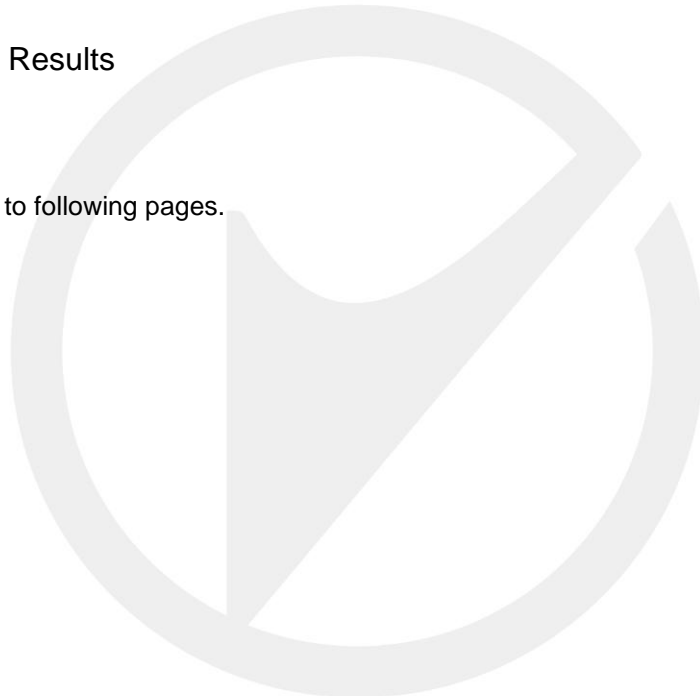

■ Radiated Emission Above 1GHz

Test mode: ON Humidity: 55%
 Temperature: 24°C Test Voltage: AC 120V/60Hz
 Test Date: 2021-11-29

Freq. (MHz)	Ant.Pol. H/V	Emission Level(dBuV/m)		Limit 3m(dBuV/m)		Over(dB)	
		PK	AV	PK	AV	PK	AV
2913.740	V	39.50	35.40	74.00	54.00	-34.50	-18.60
4430.628	V	41.10	36.10	74.00	54.00	-32.90	-17.90
6285.695	V	43.40	34.20	74.00	54.00	-30.60	-19.80
8176.795	V	45.80	40.50	74.00	54.00	-28.20	-13.50
10274.23	V	47.30	43.20	74.00	54.00	-26.70	-10.80
11600.35	V	48.30	42.60	74.00	54.00	-25.70	-11.40
3186.869	H	39.00	34.30	74.00	54.00	-35.00	-19.70
4640.339	H	41.00	36.30	74.00	54.00	-33.00	-17.70
5830.640	H	41.20	37.10	74.00	54.00	-32.80	-16.90
7454.429	H	44.00	37.60	74.00	54.00	-30.00	-16.40
9895.349	H	45.70	38.10	74.00	54.00	-28.30	-15.90
11044.12	H	44.40	37.20	74.00	54.00	-29.60	-16.80



7. PHOTOGRAPHS

7.1. Photo of Conducted Emission Measurement

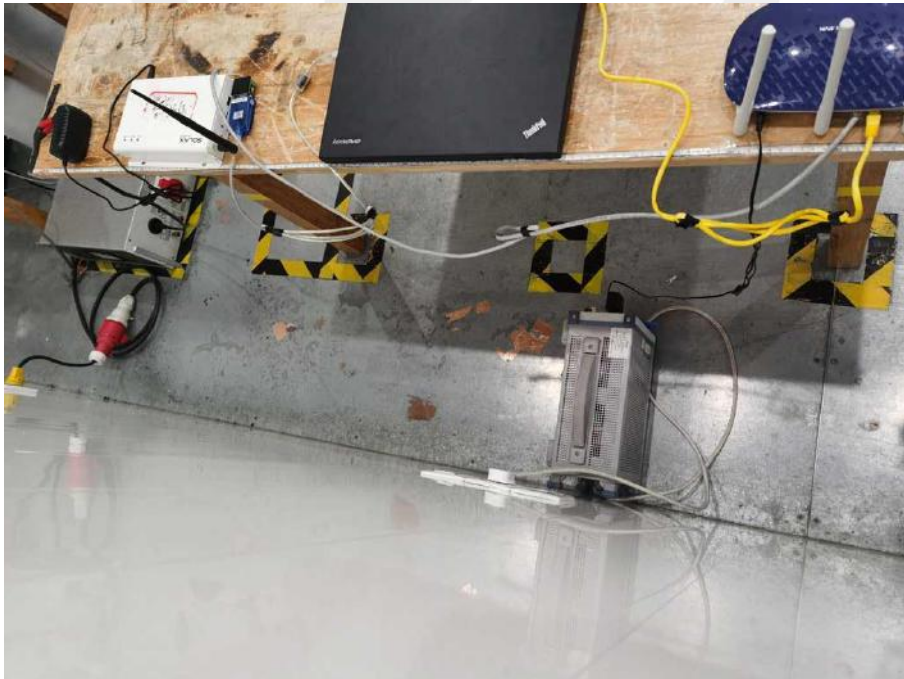

7.2. Photo of Radiation Emission Measurement (Up to 1GHz)

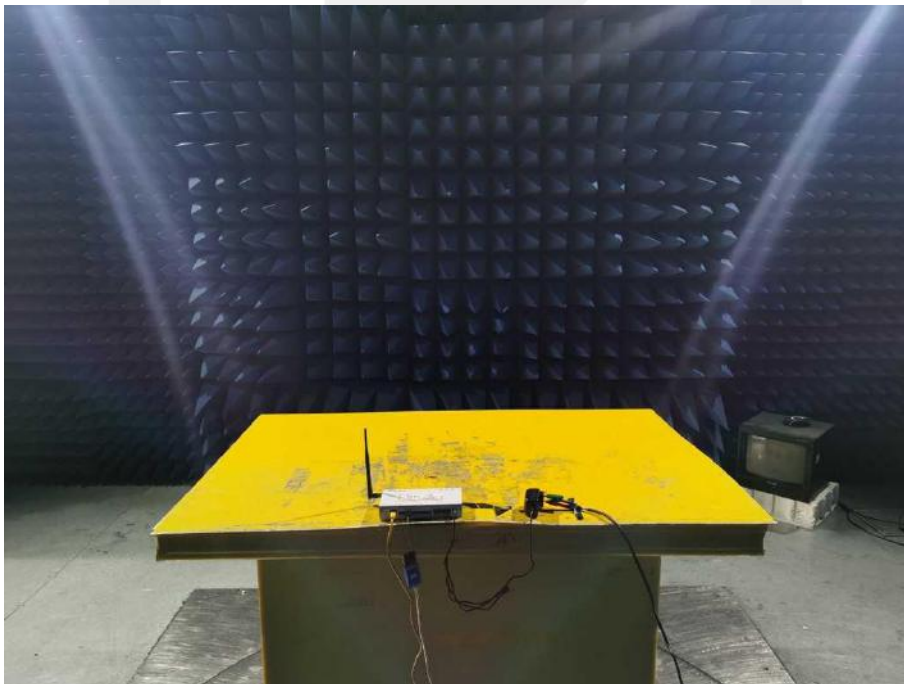
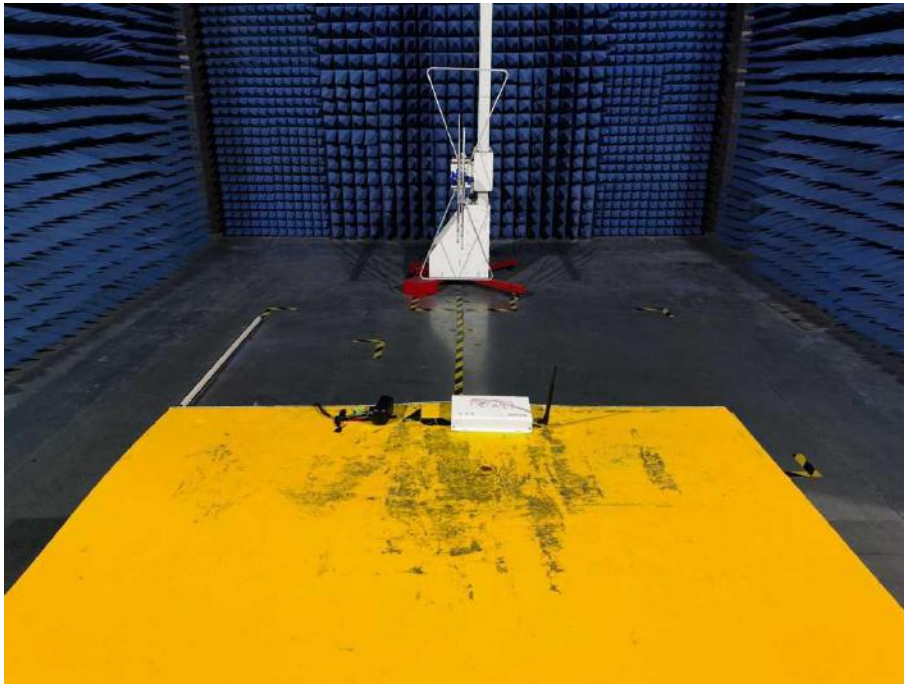

7.3. Photo of Radiation Emission Measurement (Above 1GHz)

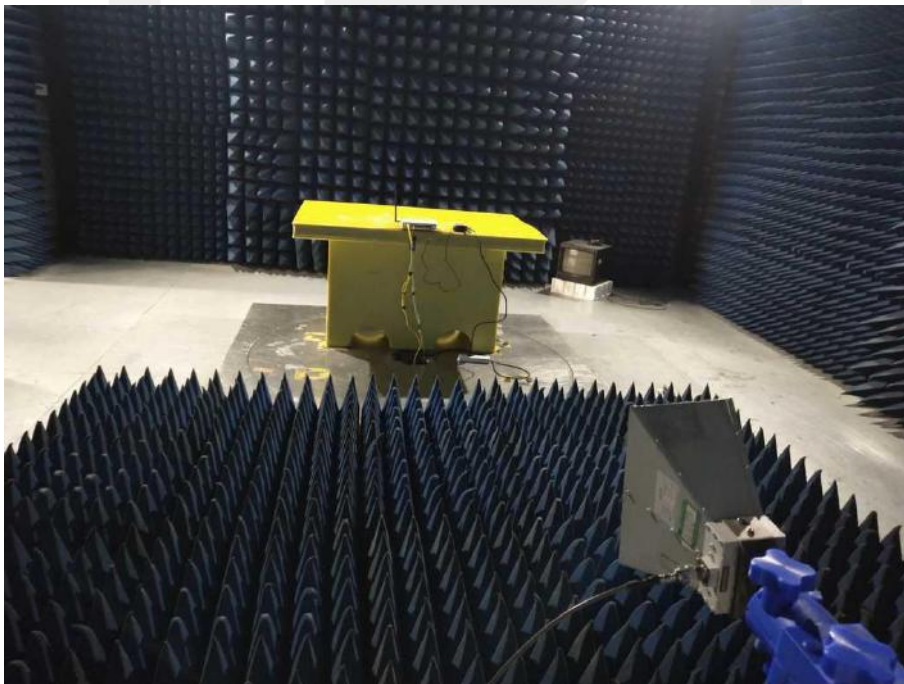
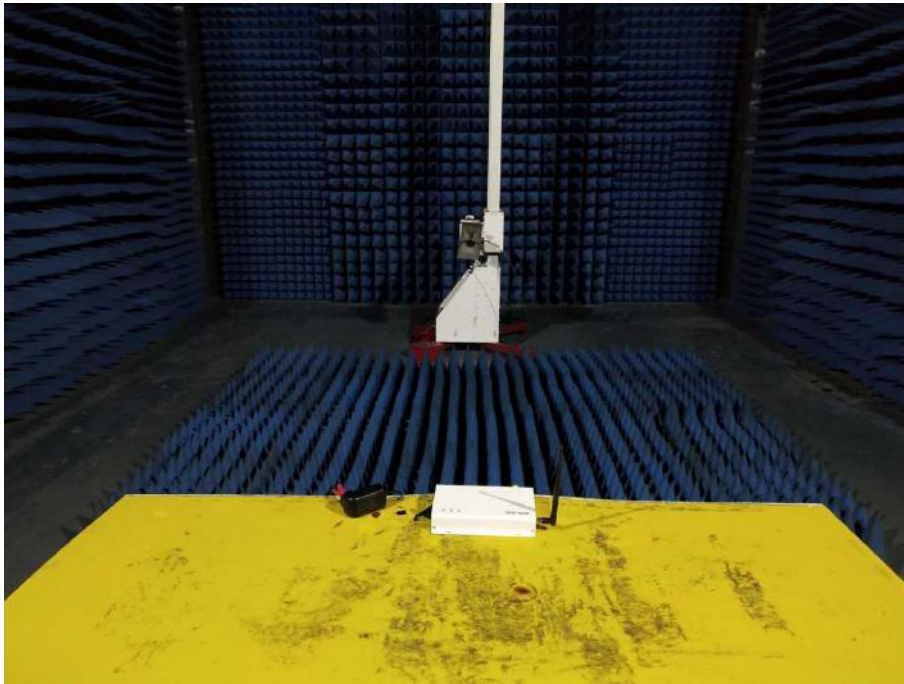

APPENDIX A: Warning Labels

Label Requirements

A Class B digital device subject to Declaration of Conformity of FCC shall carry a label which includes the following statement:

***** WARNING *****

This device complies with part 15 of the FCC Rules. Operation is subject to the following two conditions: (1) This device may not cause harmful interference, and (2) this device must accept any interference received, including interference that may cause undesired operation.

The sample label shown shall be permanently affixed at a conspicuous location on the device and be readily visible to the user at the time of purchase.



APPENDIX B: Warning Statement

Statement Requirements

The operators' manual for a Class B digital device shall contain the following statements or their equivalent:

***** WARNING *****

This equipment has been tested and found to comply with the limits for a Class B digital device, pursuant to Part 15 of the FCC Rules. These limits are designed to provide reasonable protection against harmful interference when the equipment is operated in a residential installation. This equipment generates, uses, and can radiate radio frequency energy and if not installed and used in accordance with the instruction manual may cause harmful interference to radio communications. However, there is no guarantee that interference will not occur in a particular installation. If this equipment does cause harmful interference to radio or television reception, which can be determined by turning the equipment off and on, the user is encouraged to try to correct the interference by one or more of the following measures:

- Reorient or relocate the receiving antenna.
- Increase the separation between the equipment and receiver.
- Connect the equipment into an outlet on a circuit different from that to which the receiver is connected.
- Consult the dealer or an experienced radio TV technician for help.

Notice: The changes or modifications not expressly approved by the party responsible for compliance could void the user's authority to operate the equivalent.

If the EUT was tested with special shielded cables the operators manual for such product shall also contain the following statements or their equivalent:

Shielded interface cables and/or AC power cord, if any, must be used in order to comply with the emission limits.

APPENDIX C: Photos of EUT

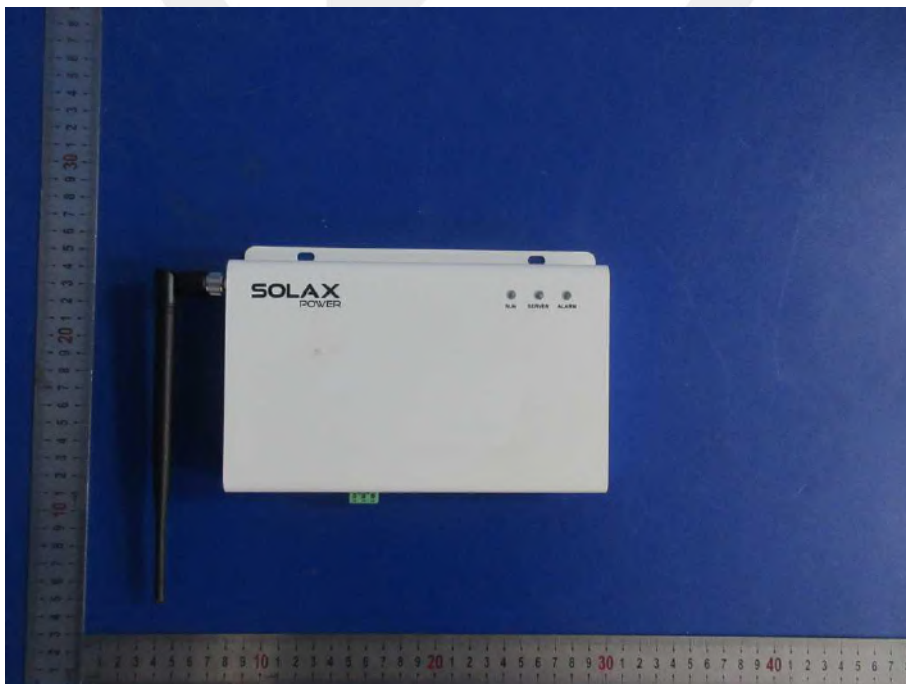
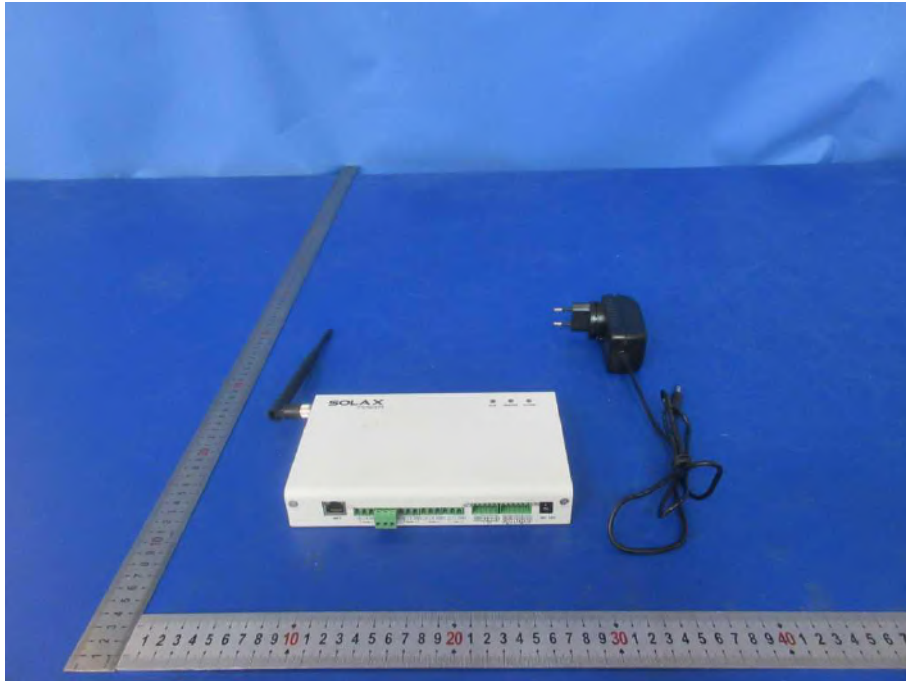

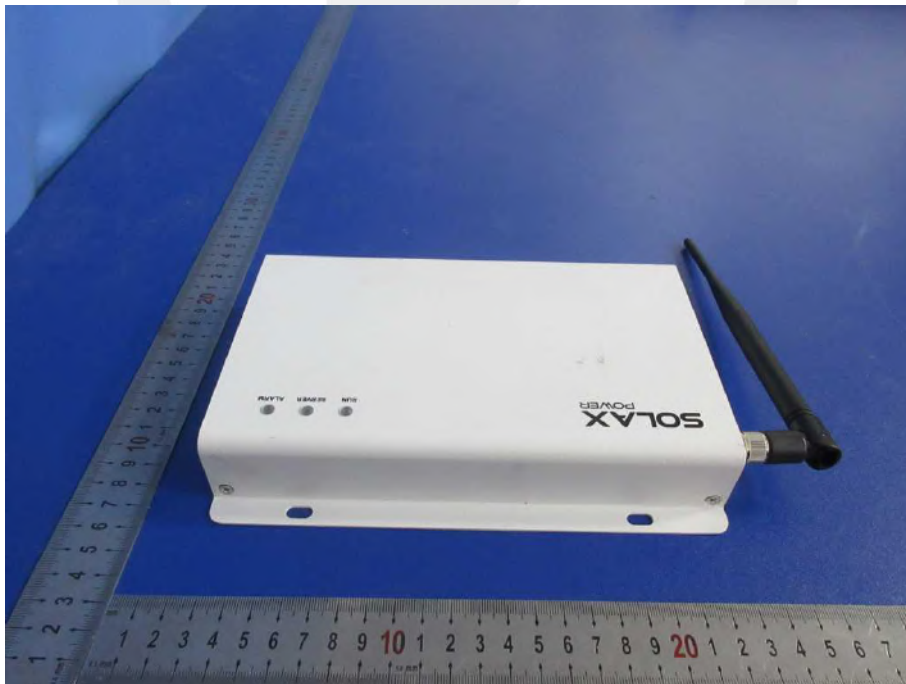

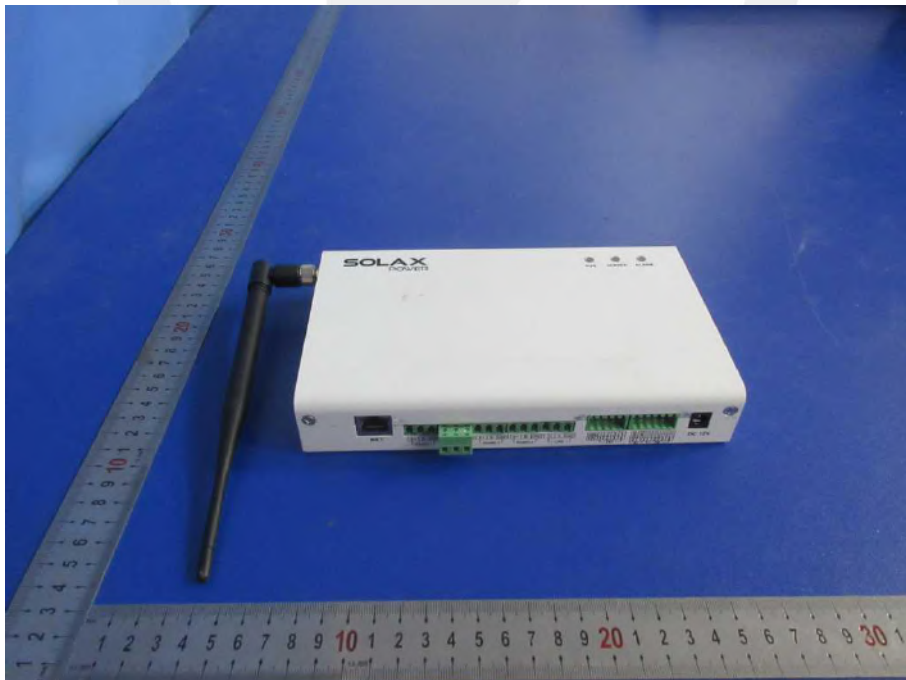

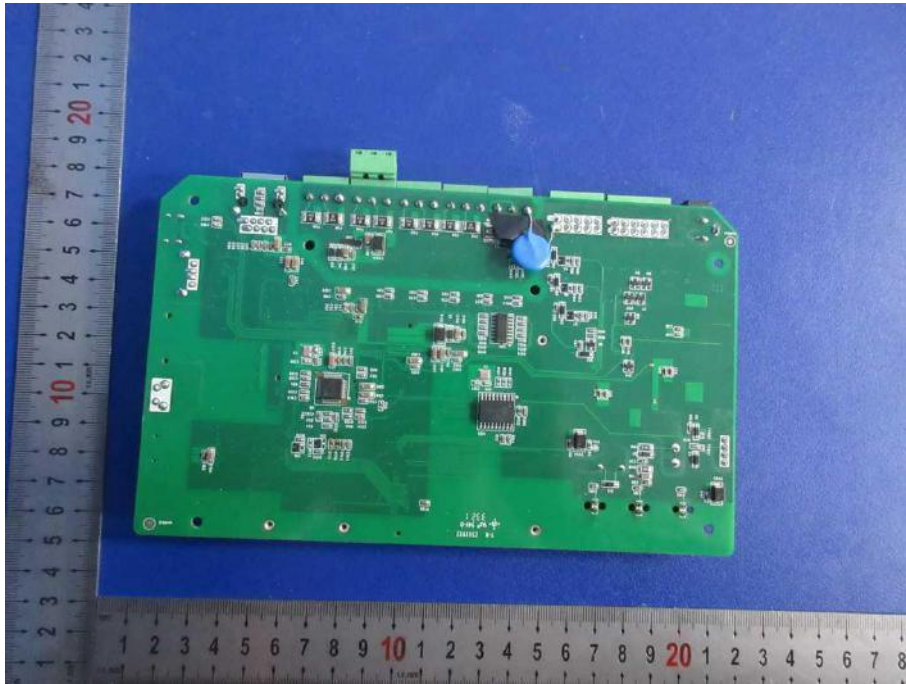

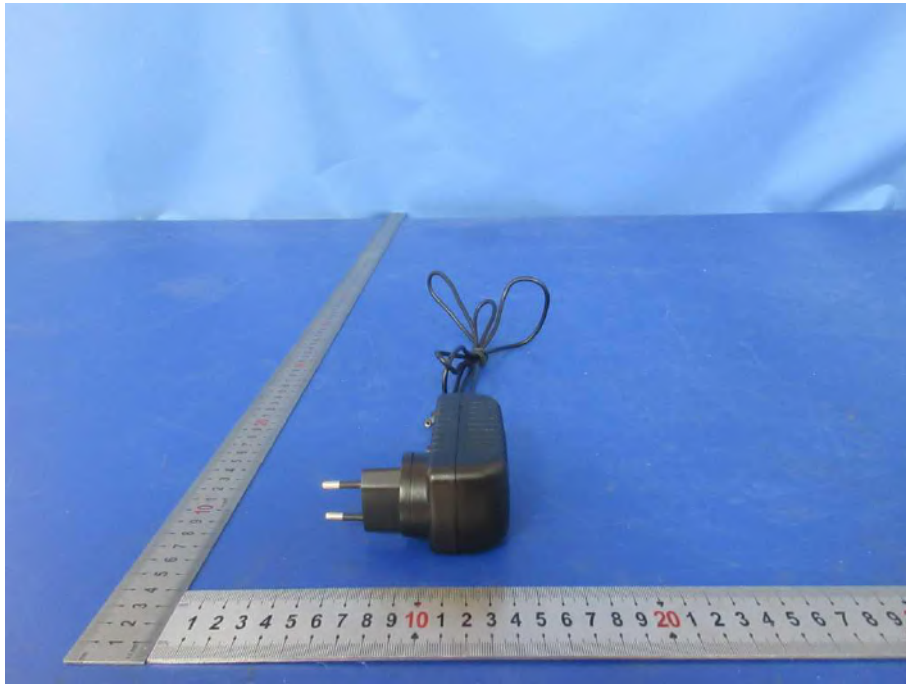

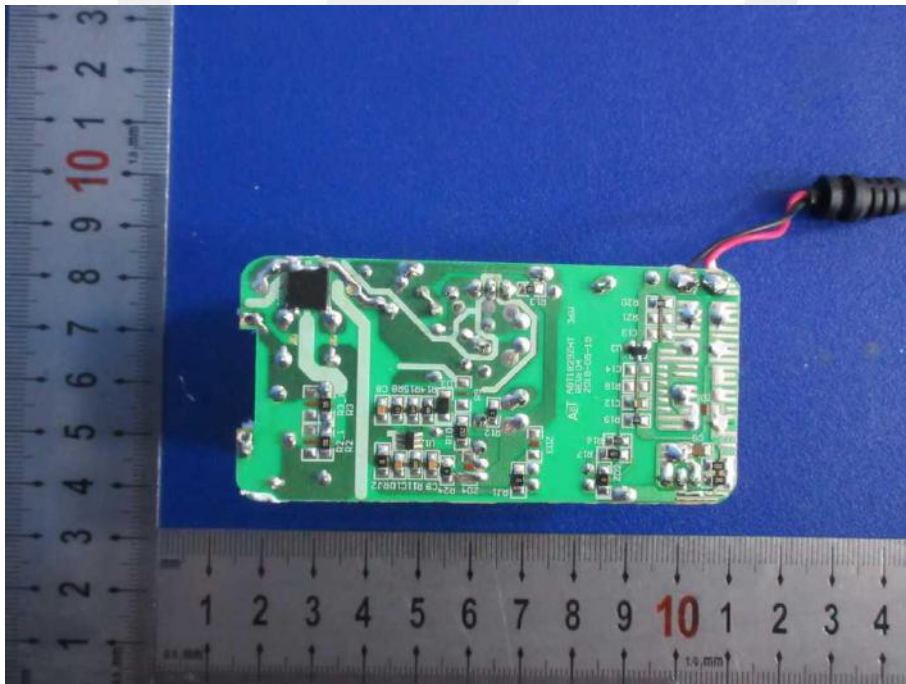



*** End of Report ***

声明 Statement

1. 本报告无授权批准人签字及“检验报告专用章”无效；
This report will be void without authorized signature or special seal for testing report.
2. 未经许可本报告不得部分复制；
This report shall not be copied partly without authorization.
3. 本报告的检测结果仅对送测样品有效，委托方对样品的代表性和资料的真实性负责；
The test results or observations are applicable only to tested sample. Client shall be responsible for representativeness of the sample and authenticity of the material.
4. 本检测报告中检测项目标注有特殊符号则该项目不在资质认定范围内，仅作为客户委托、科研、教学或内部质量控制等目的使用；
The observations or tests with special mark fall outside the scope of accreditation, and are only used for purpose of commission, research, training, internal quality control etc.
5. 本检测报告以实测值进行符合性判定，未考虑不确定度所带来的风险，本实验室不承担相关责任，特别约定、标准或规范中有明确规定的除外；
The test results or observations are provided in accordance with measured value, without taking risks caused by uncertainty into account. Without explicit stipulation in special agreements, standards or regulations, EMTEK shall not assume any responsibility.
6. 对本检测报告若有异议，请于收到报告之日起 20 日内提出；
Objections shall be raised within 20 days from the date receiving the report.